

Mobile Computer MC 92N0^{ex}-IS

Quick Start Guide



Quick Start Guide - Translation

MC 92N0^{ex}-IS

Mobile Computer

Type 17-A1A* -****/*****

ATEX/IECEX Zone 1

UL Class I, II Division 1 and Class III

Document No.: 11-A1A2-7E0001

Status: January 2022

Proviso: Subject to technical changes. Changes, mistakes and printing errors do not substantiate any claim to damages.

Content	Pages
English	1-36

1	Basic safety information	1
1.1	Information on this Quick Start Guide.....	1
1.1.1	Languages.....	2
1.1.2	Changes in the document.....	2
1.1.3	Registered trademarks	2
1.2	Handling the product	2
1.3	Intended use.....	3
1.3.1	Exclusive purpose	3
1.3.2	Unintended use	3
1.4	Duties of the operator.....	3
1.5	Safety information.....	3
1.6	Maintenance.....	4
1.6.1	Servicing.....	4
1.6.2	Inspection	4
1.6.3	Repairs	4
1.6.4	Commissioning.....	4
1.7	Labelling, test certificate, and standards	4
1.8	Warranty.....	5
1.9	Co-applicable documents	6
1.10	Definition of terms.....	6
1.11	Configuration	7
2	Product description	8
2.1	MC 92N0 ^{ex} -IS	8
2.2	Purpose of use	8
3	Structure	9
4	Technical data.....	10
4.1	Explosion protection	10
4.2	Features	11
4.2.1	Performance features.....	11
4.2.2	Physical features	11
4.2.3	User environment	13
4.2.4	Barcode capture options.....	13
4.2.5	Reading range.....	14
4.2.6	Application development	15
4.2.7	Voice and data transmission Wireless LAN.....	16
4.2.8	Voice and data transmission Wireless PAN	17
4.2.9	Headset	17
4.3	Battery	18
4.4	Product labelling	19
4.4.1	Mobile Computer	19
4.4.2	Battery	20
4.4.3	Laser Labels.....	20
5	Transport and storage.....	21
5.1	Transport.....	21
5.2	Storage.....	21

6	Commissioning	22
	6.1 Requirements in potentially explosive atmosphere	22
	6.2 First steps	24
7	Operation	25
	7.1 Final inspection	25
	7.2 Handling	25
	7.3 Handling accessories	26
	7.3.1 Insert/change battery	26
	7.3.2 Change keypad	28
	7.3.3 Leather holster	30
	7.4 Scanning	31
8	Service, Inspection, Repair	32
	8.1 Service intervals	32
	8.2 Inspection	32
	8.3 Service and repair work	32
	8.3.1 Information on sending in for repairs	33
9	Disposal	34
10	Declaration of Conformity	35
	10.1 EU Declaration of Conformity	35
11	Note	36

1 Basic safety information

1.1 Information on this Quick Start Guide



Read carefully before putting the devices into operation.

The Quick Start Guide is a fixed part of the product. It must be kept in the direct vicinity of the device and the installation, operating and service staff must have access to it at all times.

The Quick Start Guide contains important information, safety instructions and test certificates which are necessary for the perfect function of the device in operation.

The Quick Start Guide is directed at all individuals concerned with the commissioning, handling and servicing of the product. The applicable guidelines and standards for areas with gas and dust atmosphere (EN/IEC 60079-17, EN/IEC 60079-19) must be observed when conducting this work.

Knowledge of the safety and warning information in this Quick Start Guide and the strict compliance with it is essential for safe installation and commissioning. Accidents, injuries and material damage can be avoided by circumspect handling and systematically following the instructions.

The examples, tables, and figures provided in this Quick Start Guide are for illustration purposes. Due to the different requirements of the respective application, the BARTEC company cannot assume responsibility or liability for actual use based on the examples and figures.

The BARTEC company reserves the right to carry out technical changes at any time.

In no event will BARTEC company be responsible or liable for indirect or consequential damages resulting from the use or application of this Quick Start Guide.

Safety and warning information is particularly emphasised in this Quick Start Guide and marked by symbols.

DANGER

DANGER describes a directly imminent danger. If not avoided, death or severe injury will be the consequence.

WARNING

WARNING describes a possibly imminent danger. If not avoided, death or severe injury may be the consequence.

CAUTION

CAUTION describes a possibly imminent danger. If not avoided, mild or slight injury may be the consequence.

ATTENTION

ATTENTION describes a possibly damaging situation. If not avoided, the plant or objects in its vicinity may be damaged.



Important information on effective, economical & environmentally compliant handling.

1.1.1 Languages

The original Quick Start Guide is written in German. All other available languages are translations of the original Quick Start Guide.

The Quick Start Guide is available in German and English. If further languages are required, these must be requested from BARTEC or stated on placing an order.

1.1.2 Changes in the document

BARTEC reserves the right to change the content of this document without notification. No warranty is assumed for the correctness of the information. In cases of doubt, the German safety instructions apply because it is not possible to rule out errors of translation or printing. In the case of legal disputes, the "General Terms and Conditions of Business" of the BARTEC Group also apply.

The current versions of the datasheets, certificates and Declarations of conformity can be downloaded from www.bartec.com or may be requested directly from BARTEC GmbH.

1.1.3 Registered trademarks

Bluetooth®	is a registered trademark of Bluetooth Special Interest Group
Android	The "Android" name, the Android logo, the Google Play trademark and other Google trademarks are the property of Google LLC.
WiFi	is a registered trademark of Wi-Fi-Alliance, an association of manufacturers founded in 1999.

1.2 Handling the product

The product described in this Quick Start Guide left the factory in a perfect and tested state in terms of safety. To maintain this state and to achieve a perfect and safe operation of this product, it may only be operated in the manner described by the manufacturer. In addition, the perfect and safe operation of this product requires correct transportation, proper storage and careful operation.

The safe and perfect handling of the Mobile Computer is a prerequisite for its perfect and correct functioning.

1.3 Intended use

1.3.1 Exclusive purpose

The Mobile Computer is a handheld piece of electrical equipment. It serves the purpose of the mobile recording, processing and/or radio transmission of data within potentially explosive atmospheres.

It is used exclusively in combination with devices which comply with the requirements placed on the overvoltage category I.

The admissible operating data of the device used must be considered.

1.3.2 Unintended use

Any other use is unintended and may lead to damage and accidents. The manufacturer shall not be liable for any use extending beyond the exclusive purpose.

1.4 Duties of the operator

The operator undertakes to only permit persons to work with the Mobile Computer who

- are acquainted with the basic regulations on safety and accident prevention, and who have been inducted in the use of the Mobile Computer,
- have read and understood the documentation, the safety chapter and the warnings.

The operator checks that the safety and accident prevention regulations applicable to the respective case of use have been observed.

1.5 Safety information

- Do not dry wipe or clean devices in potentially explosive atmospheres!
- Do not open devices in potentially explosive atmospheres.
- Do not replace or charge battery in potentially explosive atmospheres.
- General statutory provisions or guidelines on occupational health and safety, accident prevention provisions and environmental protection laws must be heeded, e.g. Operational Safety Ordinance (BetrSichV) and nationally applicable ordinances.
- Use suitable clothing and shoes with respect to the danger of hazardous electrostatic charges.
- Avoid heat influences outside the specified temperature range.
- Protect device from external influences! Do not expose device to caustic/aggressive liquids, vapours or spray. In the case of malfunction or damaged enclosure, remove the device immediately from the potentially explosive atmosphere and bring it to a safe place.

1.6 Maintenance

The pertinent erection and operating provisions for electrical systems must be observed! (e.g. Directive 2014/34/EU, BetrSichV and nationally applicable ordinances EN/IEC 60079-14 and the series DIN VDE 0100)!

Observe the national waste disposal regulations when disposing of the devices.

1.6.1 Servicing

No constant servicing will be necessary if operated correctly under consideration of the assembly instructions and environmental conditions. See chapter: Service, inspection, repair in this respect.

1.6.2 Inspection

According to EN/IEC 60079-17 and EN/IEC 60079-19 the operator of electrical systems in potentially explosive atmospheres is obliged to have these inspected by an electrician to ensure correct condition.

1.6.3 Repairs

Repairs to explosion-protected devices may only be performed by authorised personnel with original spare parts and according to the state of the art.

Therefore all repairs to the Mobile Computer have to be conducted by BARTEC.

Contact information and instructions for repair requests and processing can be found at:

<https://www.bartec.de/en/products/automation-enterprise-mobility/>

- Procedure guide
- RMA Form

1.6.4 Commissioning

It must be checked that all components and documents are available before commissioning.

1.7 Labelling, test certificate, and standards

Labels on explosion protection and the test certificate are attached to the Mobile Computer. Labelling see chapter: Technical Data.

The guidelines and standards applicable to the Mobile Computer for devices and protected systems for intended use in potentially explosive atmospheres see chapter: Declaration of Conformity.

1.8 Warranty

WARNING

No changes or retrofits may be made without the written consent of the manufacturer.

If non-specified components are used, the explosion protection will no longer be guaranteed. In the case of externally procured parts, it is not guaranteed that these have been designed and manufactured in accordance with their load and requisite safety.

- ▶ Contact the manufacturer before any changes or retrofits to receive a release. Only use original spare and wearing parts.



The manufacturer shall exclusively assume the complete warranty only for spare parts ordered from him.

Our “General Terms and Conditions of Sale and Delivery” shall apply in principle. These shall be made available to the operator on signing of contract at the latest. Warranty and liability claims in the case of injury and damage to property shall be excluded if they are attributable to one or several of the following causes:

- Unintended use of the Mobile Computer.
- Incorrect handling
- Failure to observe the information in the Quick Start Guide and the User Manual with respect to transport, storage, commissioning, operation and service.
- Independent structural changes
- Faulty monitoring of parts subject to wear and tear.
- Incorrectly performed repairs.
- Cases of disaster through the impact of foreign bodies and force majeure.

We grant a warranty period of one year starting from the date of delivery from the Bad Mergentheim factory on the Mobile Computer (exception: battery 6 months). The warranty period for accessories is one year starting from the date of delivery from the Bad Mergentheim factory. This warranty covers all parts of the delivery and shall be restricted to the free replacement or repair of the defective parts in our Bad Mergentheim factory. For this purpose, any packaging supplied must be kept where possible. In the case of warranty, the goods must be returned to us after written agreement using an RMA form. There shall be no claim to repair at the sight of erection.

The information contained herein refers to the explosion-protected version of the Mobile Computer MC 92N0^{ex}-IS.

This Quick Start Guide contains all important information on the subject of explosion protection.

Further product information on handling and commissioning can be found on the BARTEC support page: <https://automation.bartec.de/mobileE.htm>

1.9 Co-applicable documents



All documents are available online from the following websites:

BARTEC: www.bartec.com or <http://automation.bartec.de>

ZEBRA: www.zebra.com

In the event of an overlaps with Zebra, the instructions of BARTEC apply.

Document BARTEC	Explanation
User manual Mobile Computer MC 92N0^{ex}	This user manual describes the use of the explosion-protected version of the Mobile Computer MC 92N0 ^{ex}
Quick Start Guide Mobile Computer MC 92N0^{ex}-IS	The safety relevant information, initial use and further data of the Mobile Computer MC 92N0 ^{ex} -IS are described in this Quick Start Guide.
Data sheet Mobile Computer MC 92N0^{ex}-IS	This technical data sheet contains the most important explosion-relevant technical data as well as general technical data.
Document ZEBRA	Explanation
For MC9200 <ul style="list-style-type: none"> ▪ MC92 Mobile Computer Quick Start Guide ▪ MC92 Mobile Computer Integrator Guide ▪ MC92 Mobile Computer User Guide 	Instructions for commissioning, operating, configuring, programming and maintaining of the Mobile Computer.

1.10 Definition of terms

A few abbreviations are used in the documentation.

IS	=	Intrinsically Safe => is used as generic term Zone 1 and Division 1 versions
MC	=	stands for the entire product series of Mobile Computer

1.11 Configuration



The devices are only supplied with preinstalled operating system.
 Customer software or further applications are not contained in the delivery.

This Quick Start Guide refers to the following configurations:

Configuration	Version
Processor	TI OMAC 4430 Dual-Core/1GHz
Display	3.7" VGA Color Display
Memory	1 GB
Mass storage	2 GB
Operating system	<ul style="list-style-type: none"> ▪ Windows WEH 6.5.3 ▪ Windows CE 7.0 ▪ Android 4.4.4.
WLAN	WIN CE/WEH: 802.11 a/b/g/n/d/h/i Android: 802.11 a/b/g/n/d/h/i/k/r
Bluetooth	WIN CE/WEH: Microsoft-Stack: Bluetooth 2.1 EDR Stonestreet-Stack: Bluetooth 4.0 plus BLE or WBA Android: Bluetooth 4.0 BLE
Scanner Options	SE965-SR: 1D scan engine with standard range SE1524-ER: 1D scan engine with extended range SE4500-SR: Omnidirectional 1D/2D engine for image capture of 1D and 2D symbols SE4500-HD: 1D/2D DPM engine for image capture with several DPMs

2 Product description

2.1 MC 92N0^{ex}-IS

The MC 92N0^{ex}-IS is a tough Mobile Computer with 3.7" color display, which has been designed for use in the industrial environments and especially developed by BARTEC in close cooperation with ZEBRA for use in potentially explosive atmospheres.



2.2 Purpose of use

The Mobile Computer MC 92N0^{ex}-IS are handheld electrical devices. They serve the purpose of entry, processing and (radio) transmission of data within potentially explosive atmospheres.

The Mobile Computer MC 92N0^{ex}-IS are used exclusively in combination with devices which comply with the requirements placed on the overvoltage category I.

The **Mobile Computer MC 92N0^{ex}-IS, Type 17-A1A* -****/******* have been modified for use in the following potentially explosive atmospheres:

- ATEX / IECEx Zone 1
- Class I, II Division 1 and Class III

3 Structure

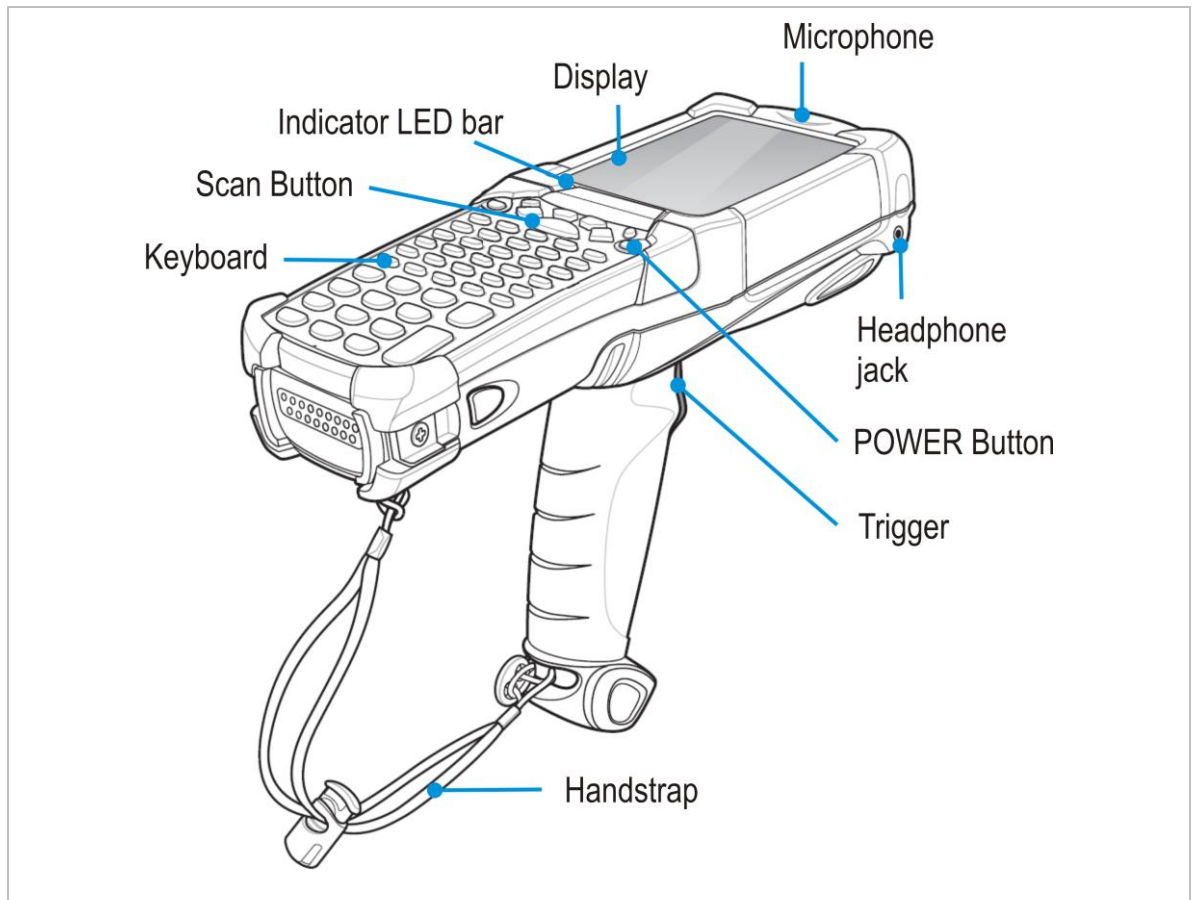

4 Technical data

4.1 Explosion protection

ATEX Zone 1	
Type	17-A1A3-****/***** MC 92N0 ^{ex} -IS
Labelling	 II 2G Ex q [ib] IIC T4 Gb
Test certificate	PTB 13 ATEX 2019 X
Standards	See chapter: EU Declaration of Conformity
IECEx Zone 1	
Type	17-A1A3-****/***** MC 92N0 ^{ex} -IS
Labelling	Ex q [ib] IIC T4 Gb
Test certificate	IECEx PTB 13.0043X
Standards	See chapter: EU Declaration of Conformity
Class I, II, III, Division 1	
Type	17-A1A2-****/***** MC 92N0 ^{ex} -IS
Labelling	Class I Division 1 Groups C und D Class II Division 1 Groups F und G Class III
Test certificate USA and Canada	UL E226123
Standards	USA Standard UL 913, 5 Edition. Canada National Standard C22.2 Nr. 157-92

X - labelling (special conditions of use for secure operation within the potentially explosive atmosphere)

The ambient temperature range is $-20\text{ °C} \leq T_a \leq +50\text{ °C}$.*

The device must be protected from impact with high impact energy, from intense UV-irradiation, and strongly charge generating processes.

It is not allowed to use connectors inside the potentially explosive atmosphere.*

It is not allowed to remove, change and/or charge the battery inside the potentially explosive atmosphere.*

The battery must be locked within the potentially explosive atmosphere.*

*See individual chapters on the items in this Quick Start Guide.

4.2 Features

4.2.1 Performance features

CPU	Dual-Core 1 GHz OMAP 4430-Prozessor
Operating system	<ul style="list-style-type: none"> ▪ Windows WEH 6.5.3 ▪ Windows CE 7.0 ▪ Android 4.4.4.
Memory	4 GB RAM; 32 GB Flash
Extension slot	SD card slot with SDHC support (up to 32 GB)
Interfaces	RS232 USB

4.2.2 Physical features

Dimensions: (Length x Width x Height)	<p>MC 92N0ex-G: 231 x 91 x 193 mm (9.1 x 3.6 x 7.6 inch)</p> <p>MC 92N0ex-K: 231 x 91 x 56 mm (9.1 x 3.6 x 2.3 inch)</p>
Weight (including battery)	<p>MC 92N0ex-G: Type 17-A1A3-****/***** (ATEX/IECEX Zone 1) approx. 1060 g (2.3 lb) Type 17-A1A2-****/***** (UL Div. 1) approx. 830 g (1.8 lb)</p> <p>MC 92N0ex-K: Type 17-A1A3-****/***** (ATEX/IECEX Zone 1) approx. 980 g (2.2 lb) Type 17-A1A2-****/***** (UL Div. 1) approx. 700 g (1.5 lb)</p>
Display	<p>3.7" VGA-colour display</p> <p>VGA mode: 480 x 640 pixel (width x height)</p> <p>QVGA mode (Windows CE only): 240 x 320 pixel (width x height)</p>
Touchscreen	Analogue-resistive touchscreen
Background lighting	LED technology
Network connections	Ethernet (via charge station); USB 2.0, Host or Client
Interactive sensor technology	<ul style="list-style-type: none"> ▪ Three-axes accelerometer for motion sensor application for dynamic screen orientation ▪ power monitoring ▪ recognition of free fall

Keypad versions

- 28 Keypad (Numeric keys can be used direct, Alpha keys and other key functions can be used via function keys)



- 43 Keypad (Numeric- and Function keys can be used direct, Alpha keys and other key functions can be used via function keys)

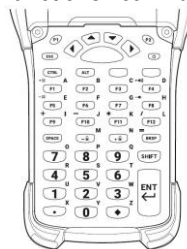

- 53 Keypad (Numeric- and Alpha keys can be used directly, other key functions can be used via function keys)

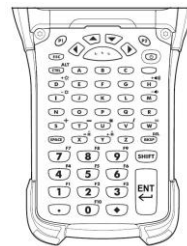

- 53 Keypad with layout for VT Emulation

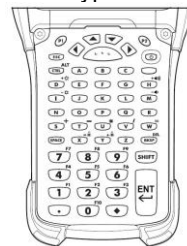

No emulation software is installed on the Mobile Computers with the emulation key version. The customer must order the emulation software separately from ZEBRA and its distributors and install it himself.

The devices are modified to suit the selected keypad version. The end user can replace the keypad later himself.

When replacing the keyboard, follow the instructions in this Quick Start Guide.

4.2.3 User environment

Operating temperature	-20 °C to +40 °C (-4 °F to +104 °F)
Charging temperature	0 °C to +40 °C (+32 °F to +104 °F)
Storage temperature (without battery)	-40 °C to +70 °C (-40 °F to +158 °F)
Relative humidity	5 % to 95 % (non-condensing)
Class of protection (IEC 60529)	Type 17-A1A3-****/***** (ATEX/IECEX Zone 1) IP 54 Type 17-A1A2-****/***** (UL Div. 1) IP 64

4.2.4 Barcode capture options

Barcode capture	Available operating systems		Form	
	Windows CE/WEH	Android 4.4.4	MC92N0 Gun	MC92N0 Brick
1D-Barcodes				
SE965-SR 1D Standard Range Scan Engine	Yes	Yes	Yes	Yes
SE1524-ER 1D Extended Range Scan Engine	Yes	Yes	Yes	No
1D-/2D Barcodes				
SE4500-SR 1D-/2D Omni-Direktional Imager Engine	Yes	Yes	Yes	Yes
DPM/1D-/2D Barcodes				
SE4500-HD DPM/1D-/2D Imager Engine	Yes	No	Yes	Yes

4.2.5 Reading range

Barcode capture	Reading range	
	minimum	maximum
1D-Barcodes		
SE965-SR 1D Standard Range Scan Engine	2.5 cm 0.98 inch	130 cm 51.18 inch
SE1524-ER 1D Extended Range Scan Engine	5 cm 1.97 inch	1370 cm 539.37 inch
1D-/2D Barcodes		
SE4500-SR 1D-/2D Omni-Directional Imager Engine	5 cm 1.97 inch	60 cm 23.62 inch
DPM/1D-/2D Barcodes		
SE4500-HD DPM/1D-/2D Imager Engine	3.5 cm 1.38 inch	28 cm 11.02 inch



The scanning range of the different scan engines depends on the used barcode type, the print quality and the module width (in mil).

The scan engines used comply with laser class CDRH Class II / IEC 825 Class 2. Further detailed information on the used scan engine can be found in the “User Manual“ or “Integrator Guide“ from ZEBRA.

4.2.6 Application development

Software	<p>No functional changes were made to the device because of the explosion protection. All tools and applications available from Zebra for the MC9200 are compatible with the MC92N0ex version.</p> <p>E.g. applications for:</p> <ul style="list-style-type: none"> - Communication and message exchange - additional Mobility DNA solutions from Zebra (Enterprise Keyboard, Stage Now, Enterprise Browser, Enterprise Start Screen, SimulScan, and more)
Software Development	<p>PSDK (Platform Software Development Kit) and EMDK (Enterprise Mobility Developer Kit) is available via the ZEBRA Solutions Website.</p>
Available for	<ul style="list-style-type: none"> ▪ C ▪ .Net ▪ Android ▪ Xamarin ▪ MC9200 Platform SDK (PSDK) ▪ others
Browser support	<p>Enterprise Browser from ZEBRA for application development.</p>
Mobility DNA applications from Zebra	<p>CtlPanelIWM for the processing of device settings</p> <p>Application Launcher for the classification of applications in categories and access regulation for individual applications or operating system.</p> <p>Data Wedge Barcodes in applications can be read such as Excel or Word using.</p> <p>Enterprise Home Screen for Android Provides administrators with an easy way to control access to apps and settings on a Zebra device without writing custom code.</p> <p>More utilities can be found on the Zebra support page for the MC9200 : https://www.zebra.com/us/en/support-downloads/mobile-computers/handheld/mc9200.html</p>

4.2.7 Voice and data transmission Wireless LAN

WLAN radio module	
Radio standard	Android: IEEE 802.11 a/b/g/n/d/h/i/k/r WinCE/WEH: IEEE 802.11 a/b/g/n/d/h/i Note: IEEE802.11 a is not available in Thailand
Output power	100 mW (USA and International)
Data rate	IEEE802.11a: up to 54 Mbit/sec. IEEE802.11b: up to 11 Mbit/sec. IEEE802.11g: up to 54 Mbit/sec. IEEE802.11n: up to 72,2 Mbit/sec.
Frequency range (country-dependent)	IEEE802.11a: 5 GHz IEEE802.11b: 2.4 GHz IEEE802.11g: 2.4 GHz IEEE802.11n: 2.4 GHz and 5 GHz
Operating channels	IEEE802.11a Channel 8 - 165 5040 MHz - 5825 MHz IEEE802.11b/g Channel 1 - 13 2412 MHz - 2472 MHz Channel 14 2484 MHz Japan only The actual operating channels and frequencies are subject to the applicable rules and the certification authorities.
Safety	WPA2 Enterprise, 802.1x; EAP-TLS; TTLS (CHAP, MS-CHAP, MS-CHAPv2, PAP or MD5); PEAP (TLS, MSCHAPv2, EAP-GTC); LEAP, EAP-FAST (TLS, MS-CHAPv2, EAP-GTC), WPA2/AES, CCX v4, FIPS 140-2 conform and IPv6
Language support	Voice over IP Voice directed picking Tech Speech Pro approved voice-enabled applications over third-party VDP clients (Windows operating system only) Push-to-talk, workforce connect PTT express (client included) with headset and handsfree, wired headset support
Antenna	internal

4.2.8 Voice and data transmission Wireless PAN

Bluetooth	Windows operating system: Microsoft stack: (preinstalled by default) Bluetooth Version 2.1 with EDR Stonestreet stack (can be optionally activated) Bluetooth 4.0 Plus BLE or WBA Android operating system: Bluetooth version 4.0 with low energy consumption
Maximum Output Power	2,5 mW
Maximum data rate	up to 2.1 Mbit/s
Antenna	Internal chip antenna

4.2.9 Headset

Headset Connector	Ex-relevant information on the use of a headset.
Ex protection	Ex ib IIC
	$U_0 = 8.6 \text{ V}$
	$I_0 = 354 \text{ mA}$
	$P_0 = 479 \text{ mW}$
	$C_0 = 930 \text{ nF}$
	$L_0 = 460 \text{ }\mu\text{H}$

4.3 Battery



The life of the battery will depend on different use factors and the device settings, e.g.:

- Use and setting of WLAN/Bluetooth
- Background lighting/screensaver
- The settings in power management
- Use and setting of scanner

Battery	(only change and charge in the safe area)
Type 17-A1Z0-0001	Lithium Ion battery 7.2 / 2800 mAh (20.16 Wh) for MC 92N0ex, Type 17-A1A3-****/*****
Type 17-A1Z0-0023	Lithium Ion battery 7.4 / 2600 mAh (19.3 Wh) for MC 92N0ex, Type 17-A1A2-****/*****
Operating temperature	
▪ During charging	0 °C to +40 °C (+32 °F to 104 °F)
▪ During discharging	-20 °C to +50 °C (-4 °F to 122 °F)
Storage temperature	-20 °C to +50 °C (-4 °F to 122 °F)
Relative humidity	20 % to 95 % (non condensing)
Backup battery	Ni-MH battery 2.4 V/15 mAh (rechargeable) Integrated in the device and only replaceable in the factory.
Battery performance	approx. 8 hours depending on the device settings
Charging times	Depends on the selected charging station. less than 8 hours.
UN38.3 compliant	Yes





Charge the batteries at temperatures from 0°C to 40°C (32°F to 104°F). The device or charging station always performs the battery charging in a safe and intelligent way. At higher temperatures, such as about +37°C (+98°F), the device or charging station can alternately activate and deactivate battery charging for a short time to keep the battery at acceptable temperatures. The device and the charging station indicate via their LED when charging is disabled due to abnormal temperatures.

4.4 Product labelling

4.4.1 Mobile Computer

A	<p>Laser warning</p> <p>CAUTION - CLASS 3R LASER LIGHT WHEN OPEN. AVOID DIRECT EYE EXPOSURE.</p> <p>ATTENTION - LUMIÈRE LASER DE CLASSE 3R, EN CAS D'OUVERTURE. EXPOSITION DANGEREUSE AU FAISCEAU.</p> <p>VORSICHT - LASERLICHT KLASSE 3R, WENN ABDECKUNG GEÖFFNET. DIREKTE BESTRAHLUNG DER AUGEN VERMEIDEN.</p>
B	<p>Laser Mark Type 17-A1A3-****/*****</p> <div style="border: 1px solid black; padding: 5px;"> <p>COMPLIES WITH 21CFR1040.10 AND 1040.11 EXCEPT FOR DEVIATIONS PURSUANT TO LASER NOTICE No. 50, DATED JUNE 24, 2007 AND IECEN 60825-1:2001/2007 & IECEN 62471:2006</p> <div style="text-align: right; font-size: 2em; font-weight: bold;">CE 0044</div> </div> <p>Laser Mark Type 17-A1A2-****/*****</p> <p><small>THIS CLASS B DIGITAL APPARATUS COMPLIES WITH CANADIAN ICES-003. CET APPAREIL NUMÉRIQUE DE LA CLASSE B EST CONFORME À LA NORME NMB-003 DU CANADA. COMPLIES WITH 21CFR1040.10 AND 1040.11 EXCEPT FOR DEVIATIONS PURSUANT TO LASER NOTICE No. 50, DATED JUNE 24, 2007, AND IECEN 60825-1:2001, 2007 & IECEN 62471:2006.</small></p> <p><small>WARNING: SUBSTITUTION OF PARTS MAY IMPAIR INTRINSIC SAFETY. TO PREVENT IGNITION OF FLAMMABLE OR COMBUSTIBLE ATMOSPHERES, DISCONNECT POWER BEFORE SERVICING. READ, UNDERSTAND AND ADHERE TO THE OPERATIONAL MANUAL. AVOID EXPOSURE. LASER LIGHT IS EMITTED FROM THIS APERTURE.</small></p> <p>FC <small>ATTENTION: TOUTE SUBSTITUTION DES COMPOSANTS PEUT COMPROMETTRE LA SÉCURITÉ INTRINSÈQUE. POUR ÉVITER L'INFLAMMATION D'ATMOSPHÈRES INFLAMMABLES OU COMBUSTIBLES, VEUILLEZ METTRE HORS TENSION AVANT L'ENTRETIEN. VEUILLEZ LIRE, PRENDRE CONNAISSANCE ET RESPECTER LES CONSIGNES DU MODE D'EMPLOI. ÉVITEZ TOUTE EXPOSITION. CET APPAREIL ÉMET UNE LUMIÈRE LASER.</small></p> <p><small>THIS DEVICE CONTAINS AN APPROVED RADIO MODULE. SEE REGULATORY GUIDE FOR PATENT AND RADIO INFORMATION SEALED! DO NOT OPEN! DO NOT CHARGE IN HAZ LOC! SEE MANUAL FOR SPECIAL CONDITIONS!</small></p>
C	<p>Laser warning</p> <div style="border: 1px solid black; padding: 5px; background-color: #ffff00;"> <p>LASERLICHT - NICHT IN DEN STRAHL BLICKEN, LASER KLASSE 2.</p> <p>LUMIÈRE LASER - NE PAS REGARDER DANS LE FAISCEAU APPAREIL A LASER DE CLASSE 2</p> <p>CAUTION: LASER LIGHT. DO NOT STARE INTO BEAM. CLASS 2 LASER PRODUCT 630-680 nm, 1 mW</p> </div>
D	<p>Type label (here Type 17-A1A3-****/*****)</p> <div style="border: 1px solid black; padding: 5px;"> <p>II 2 G Ex q [ib] IIC T4 PTB 13 ATEX 2019 X IECEx PTB 13.0043X</p> <p>ASSEMBLED IN GERMANY</p> <p>ONLY USE BATTERY PACK P/N 17-A120-0001 WARNING: THIS ENCLOSURE IS FACTORY SEALED. DO NOT OPEN! DO NOT RECHARGE IN HAZ. LOC.</p> <p>CONTAINS APPROVED RADIO MODULE TYPE: 21-148603 / 802.11 abgn, BLUETOOTH</p> <p>BARTEC GmbH 97980 BAD MERGENTHEIM GERMANY</p> </div>
E	<p>Laser warning</p> <p>CAUTION - CLASS 2 LED LIGHT. WHEN OPEN. DO NOT STARE INTO THE BEAM.</p> <p>ATTENTION - LUMINÈRE LED DE CLASSE 2. EN CAS D'OUVERTURE. NE PAS REGARDER DANS LE FAISCEAU</p> <p>VORSICHT - LED LICHT KLASSE 2. WENN ABDECKUNG GEÖFFNET. NICHT IN DEN STRAHL BLICKEN</p>

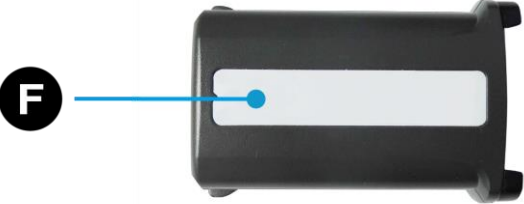
4.4.2 Battery

	
F	<p>Battery label Type 17-A1Z0-0001</p> 
	<p>Battery label Type 17-A1Z0-0023</p> 

4.4.3 Laser Labels

In compliance with IEC 60825 and EN 60825, Clause 5 the following information is provided:

<p>DEUTSCH KLASSE 1 KLASSE 1 LASER PRODUKT KLASSE 2 LASERLICHT NICHT IN DEN LASERSTRAHL SEHEN KLASSE 2 LASER PRODUKT</p>	
<p>ENGLISH CLASS 1 CLASS 1 LASER PRODUCT CLASS 2 LASER LIGHT DO NOT STARE INTO BEAM CLASS 2 LASER PRODUCT</p>	<p>FRENCH / FRANÇAIS CLASSE 1 PRODUIT LASER DE CLASSE 1 CLASSE 2 LUMIERE LASER NE PAS REGARDER LE RAYON FIXEMENT PRODUIT LASER DE CLASSE 2</p>
<p>ITALIAN / ITALIANO CLASSE 1 PRODOTTO AL LASER DI CLASSE 1 CLASSE 2 LUCE LASER NON FISSARE IL RAGGIOPRODOTTO AL LASER DI CLASSE 2</p>	<p>PORTUGUESE / PORTUGUÊS CLASSE 1 PRODUTO LASER DA CLASSE 1 CLASSE 2 LUZ DE LASER NÃO FIXAR O RAILO LUMINOSO PRODUTO LASER DA CLASSE 2</p>
<p>DUTCH / NEDERLANDS KLASSE 1 KLASSE-1 LASERPRODUKT KLASSE 2 LASERLICHT NIET IN STRAAL STAREN KLASSE-2 LASERPRODUKT</p>	<p>DANISH / DANSK KLASSE 1 KLASSE 1 LASERPRODUKT KLASSE 2 LASERLYF SE IKKE IND I STRÅLEN KLASSE 2 LASERPRODUKT</p>
<p>NORWEGIAN / NORSK KLASSE 1 LASERPRODUKT, KLASSE 1 KLASSE 2 LASERLYS IKKE STIRR INN I LYSSTRÅLEN LASERPRODUKT, KLASSE 2</p>	<p>FINNISH / SUOMI LUOKKA 1 LUOKKA 1 LASERTUOTE LUOKKA 2 LASERVALO ÄLÄ TUIJOTA SÄDETTÄ LUOKKA 2 LASERTUOTE</p>

5 Transport and storage

5.1 Transport



Report any transport damage or incomplete deliveries immediately after receipt in writing to the forwarding company and BARTEC GmbH.

Any damage caused through incorrect storage shall not be covered by the warranty provisions of BARTEC GmbH.



Battery is UN38.3 conform.

Due to the transport guidelines for air freight, all batteries are delivered ex works charged to max. 30 %.

Further information, like MSDS, can be found at

<http://automation.bartec.de/indexE.htm>

- Mobile Computer MC92N0^{ex} series
- Tab „General“

5.2 Storage

ATTENTION

Property damage through incorrect storage!

- ▶ Observe storage temperatures.
- ▶ Keep humidity away from the Mobile Computer.

Additional information on the batteries

The batteries from BARTEC (Type 17-A1Z0-0001 and 17-A1Z0-0023) are developed and manufactured in accordance with the highest industrial standards. The operating time or storage period of a battery is restricted, however. The actual life of a battery is influenced by different factors, e.g. hot, cold, rough operating environment and falling from a great height. If a battery is kept longer than six months, the performance may be impaired on a permanent basis. Keep the batteries in a dry, cool place. For longer periods of storage, remove the batteries from the device to prevent self-discharge, rusting of the metallic and the escape of electrolyte.

Batteries kept for a duration of six months or longer should be charged and discharged again at least every three months. If electrolyte has escaped, do not touch the areas affected and dispose of the batteries as prescribed. Replace the battery if the operating time has shortened considerably.

The standard warranty period for all BARTEC batteries is six months, whereby it is irrelevant whether the battery was acquired separately or was contained in the scope of the delivery of the Mobile Computer.

6 Commissioning

DANGER

Avoid electrostatic charging in potentially explosive atmosphere.

Danger to life in explosive atmosphere!

- ▶ Do not dry wipe or clean the devices.
- ▶ Wear suitable clothing and shoes.
- ▶ Do not use rubber gloves or similar.

DANGER

Unintended use endangers explosion protection.

Danger to life in explosive atmosphere!

- ▶ Do not make any changes to the Mobile Computer.
- ▶ In the case of function disturbances or damage to the enclosure, the device should be removed immediately from the potentially explosive atmosphere to a safe place. Remove battery to decommission the device!
- ▶ Do not use any battery replicas or batteries from other manufacturers.

6.1 Requirements in potentially explosive atmosphere

Mobile Computer

- The Mobile Computer may not be opened.
- Do not use, swap or replace any non-specified components.
- Do not retrofit any components to the internal plugs or slots.
- Protect the Mobile Computer from impact!
- Do not expose the Mobile Computer to caustic/aggressive liquids, vapours, mists!
- Avoid the impact of moisture outside the specifications.
- Avoid thermal impact outside the specified temperature range.
- Use the 17-pole data interface only outside the potentially explosive atmosphere and exclusively with the devices specified by the manufacturer!
- Use the headset connection only outside the potentially explosive atmosphere and exclusively with the devices specified by the manufacturer!

Battery

- The battery may not be opened.
- Only charge the battery (Type 17-A1Z0-0001 and 17-A1Z0-0023) outside the potentially explosive atmosphere.
- The battery (Type 17-A1Z0-0001 and 17-A1Z0-0023) may be changed in hazardous areas.
- To charge the battery, the charging temperature must be between 0°C and 40°C (32°F and 104°F).
- Only use the battery for the purpose listed in this Quick Start Guide and the batteries are only suitable for the Mobile Computer MC 92N0^{ex}.

Battery - Type 17-A1Z0-0001 only for MC 92N0^{ex}-IS - Type 17-A1A3-****/*****

Battery - Type 17-A1Z0-0023 only for MC 92N0^{ex}-IS - Type 17-A1A2-****/*****

- The battery must be locked within the potentially explosive atmosphere.
- There is a danger of burning if used incorrectly. Do not expose the battery to temperatures of more than +50 °C (+122 °F).
- Defective batteries must be disposed of immediately, whereby the provisions on battery disposal applicable in the respective region must be observed.
- The battery may explode if it catches fire!
- Do not short circuit the battery!

Accessories

- Only install or replace accessories outside the potentially explosive atmosphere.
- User accessories exclusively which have been tested or certified by BARTEC for this purpose.
- The end user can replace the keypad, leather holster and handstrap himself.

6.2 First steps

- ▶ Unpack the Mobile Computer.
- ▶ Insert and charge the battery into the Mobile Computer.

or

charge the battery and then insert it into the Mobile Computer.

Use one of the following accessories to charge:

Description	Charging process	
	Battery (in Mobile Computer)	Spare battery
Docking station Type: 03-9915-0003	Yes	Yes
4-slot battery charging station Type: 03-9849-0062	No	Yes

- ▶ Switch on the Mobile Computer.

Optional:

- ▶ Replace keypad.
- ▶ Use the leather holster.
- ▶ Attach hand strap.

7 Operation

The operator using an electric system in an potentially explosive environment must keep the accompanying operation equipment in a good condition, operate and monitor it correctly and conduct the requisite services and repairs. Before commissioning the devices, it must be checked that all components and documents are available.

7.1 Final inspection

The following aspects must be checked before putting the device into operation:

- ▶ Is there any damage to the display, scanner window or enclosure?
- ▶ Is the battery used certified?
- ▶ Is the battery compartment cover closed?

7.2 Handling

Optimum standby position



Right:

The Mobile Computer is protected from damage.

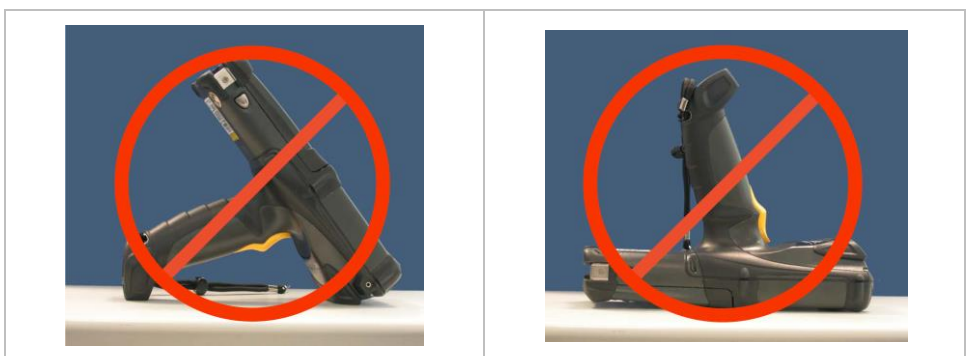

Wrong:

The Mobile Computer can be damaged by objects on the surface or may fall down.

7.3 Handling accessories

DANGER

**Non certified accessories endanger explosion protection.
Danger to life exists in potentially explosive atmospheres!**

▶ Only use original accessories from BARTEC.

Only permitted outside the potentially explosive atmosphere:

▶ Insert/charge battery.

▶ Attach/remove accessories such as keypad, leather holster and handstrap.

7.3.1 Insert/change battery

The Mobile Computer MC 92N0^{ex}-IS is supplied with a battery:

Type	Order number
Battery (EU) for ATEX / IECEx Zone 1 Lithium-ion battery 7.2 V/2800 mAh	17-A1Z0-0001
Battery (US) for UL Division 1 Lithium-ion battery 7.4 V/2600 mAh	17-A1Z0-0023

Insert battery - work steps:

1. Charge the battery only outside hazardous areas.
2. The battery (type 17-A1Z0-0001 and 17-A1Z0-0023) may be inserted/changed in hazardous areas.
3. Insert the battery into the battery compartment on the underside of the mobile computer with the battery contacts first.
4. Make sure that the battery's charging contacts agree with the charging contacts in the battery compartment.
5. Push the battery into the battery compartment until it locks into place.

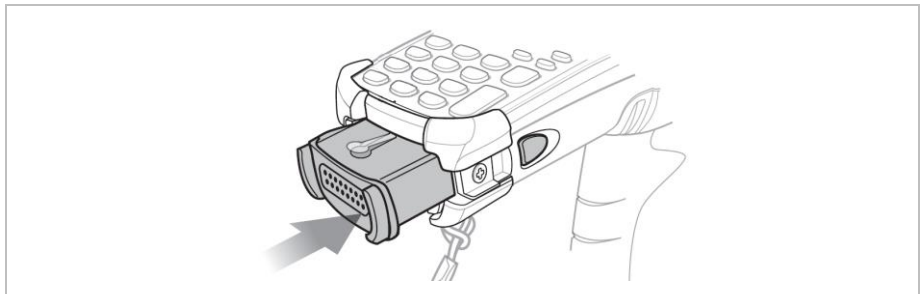

Change battery - work steps:

ATTENTION

Incorrect battery replacement may cause damage to property!

- ▶ Change the battery of the MC 92N0^{ex}-IS only in the designated areas.
- ▶ Put the MC 92N0^{ex}-IS into suspend mode before you remove the battery. Failure to properly remove the battery may cause the MC 92N0^{ex}-IS to cold boot and potential loss of data.

1. Turn off the MC 92N0^{ex}-IS with function mode "Safe Battery Swap".
2. The battery (type 17-A1Z0-0001 and 17-A1Z0-0023) may be inserted/changed in hazardous areas.
3. Use only batteries which have been tested or certified by BARTEC for this purpose.
4. To remove the battery, first unlock the side battery lock.

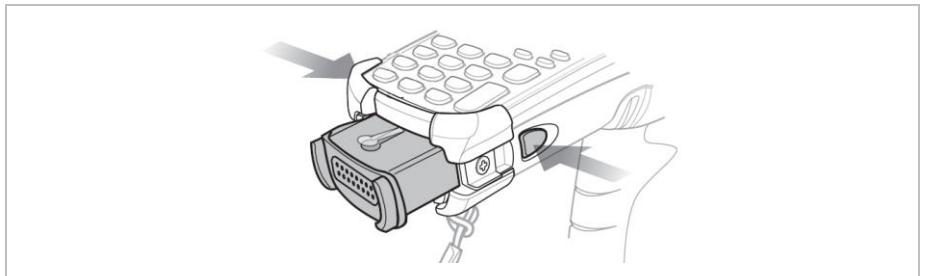

5. Then unlock the battery lock.

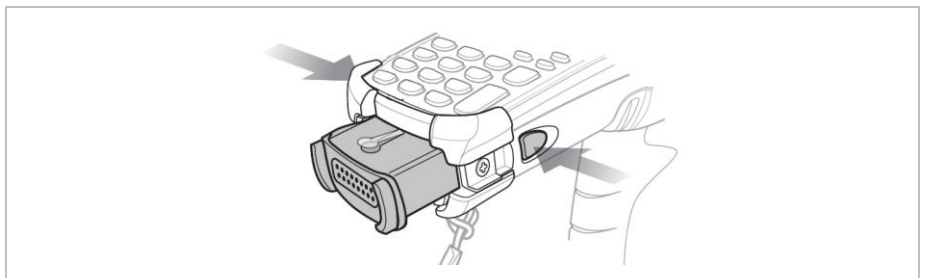

6. Remove the battery from the Mobile Computer

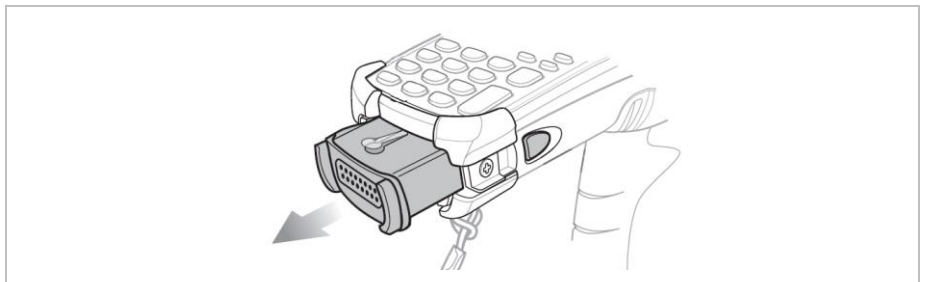

7. Insert a new one.

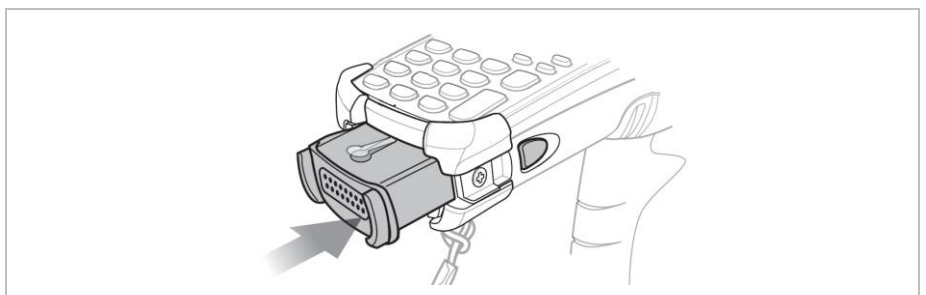

7.3.2 Change keypad

The Mobile Computer MC 92N0^{ex}-IS has interchangeable modular keypads.

⚠ DANGER

Non-certified accessories endanger explosion protection.

There is a risk of fatal injury in an explosive atmosphere!

- ▶ It must be ensured that only original keypads from BARTEC with blue overlay are used in safety-oriented operation.
- ▶ The use of imitation keypads from other manufacturers will render the type of ignition protection ineffective and there will then be a risk of fire or explosion.

Only permitted outside the potentially explosive atmosphere:

- ▶ The keypad may only be changed outside the hazardous area!
- ▶ Follow proper ESD precautions to avoid damaging the Mobile Computer. Proper ESD precautions include, but are not limited to, working on an ESD mat and ensuring that the operator is properly grounded.

ATTENTION

Incorrect handling may cause damage to property!

- ▶ Power off the MC 92N0^{ex}-IS before start of change parts.
- ▶ Put the MC 92N0^{ex}-IS into suspend mode before you remove the battery. Failure to properly remove the battery may cause the MC 92N0^{ex}-IS to cold boot and potential loss of data.

Work steps:

1. Turn off the Mobile Computer MC 92N0^{ex}-IS.
2. Remove the battery (see chapter: Insert/change battery).
3. Take out the screws at the top edge of the keypad.
4. Pull the keypad downwards in the direction of the arrow and then forwards to take it out of the MC 92N0^{ex}-IS.

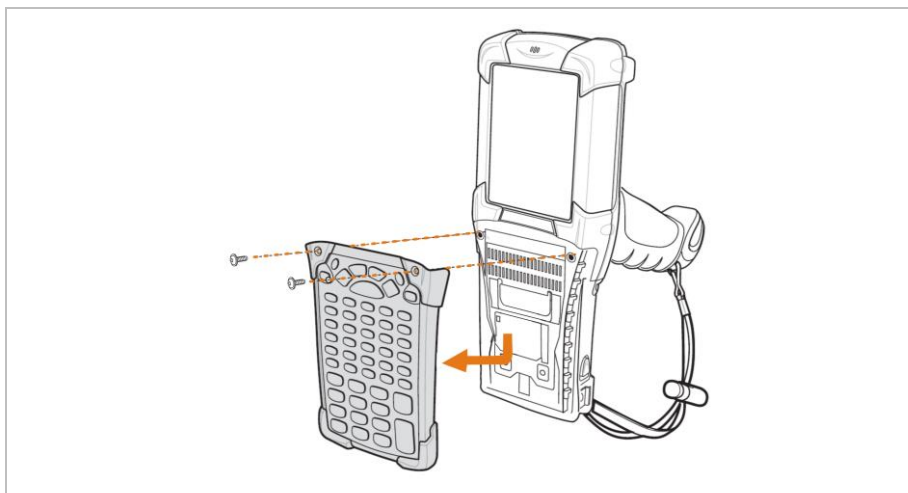

5. Check that the contacts and seals are clean and in good condition.

6. Insert both of the keyboard's guide pins into the guide grooves on the mobile computer.

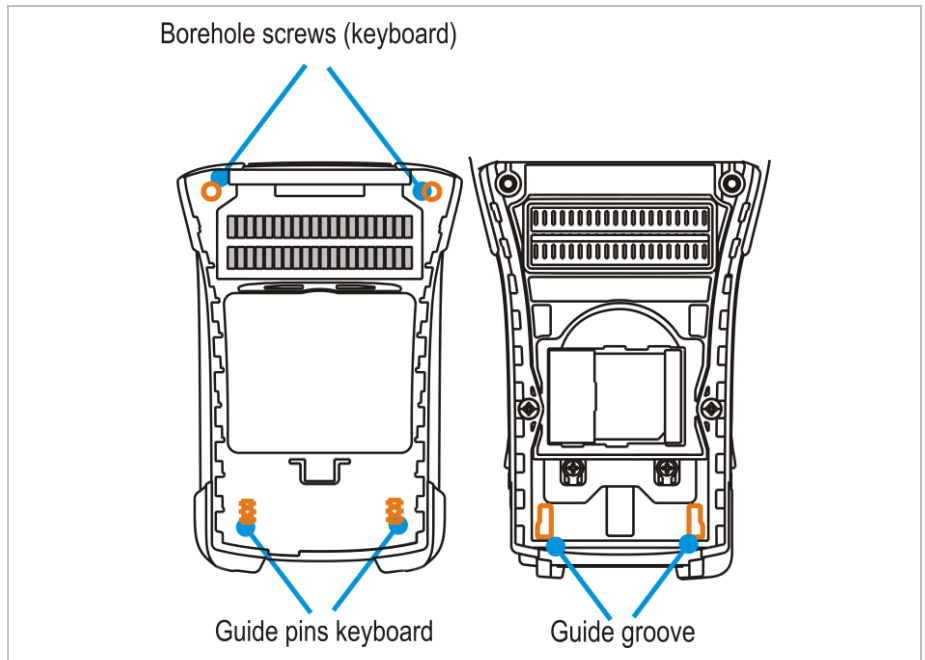

7. Snap on the keypad in the direction of the arrow and push it upwards until the boreholes for the screws are over the threaded sleeves.

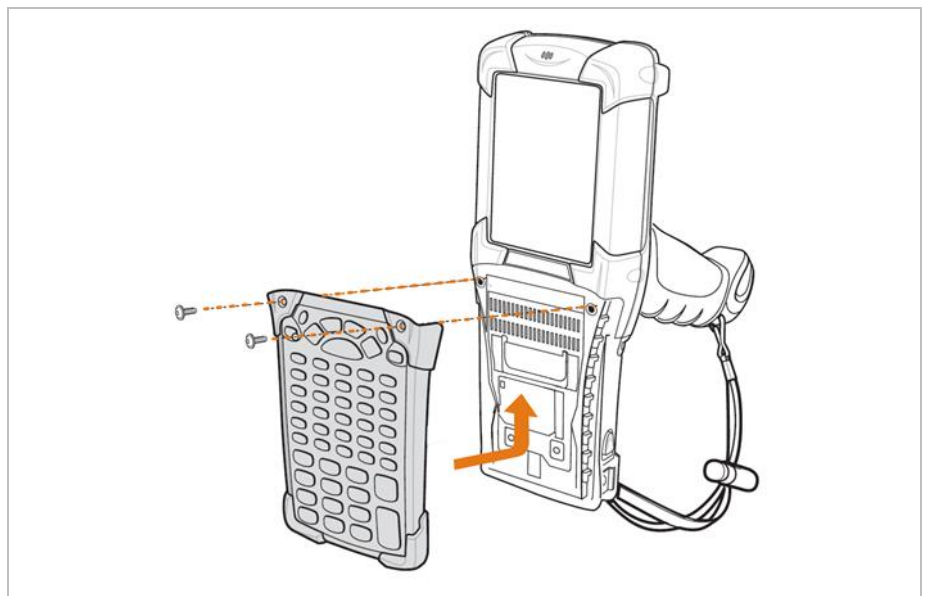

8. Check that the keypad is mounted correctly.

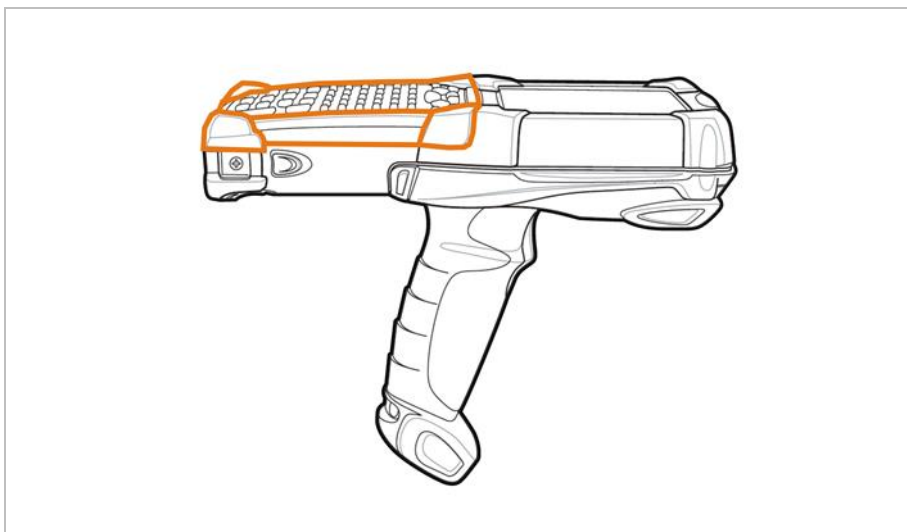

9. Tighten both screws to the device.
 (torque = 0.452 Nm / torque = 4.0 in-lbs)
10. After the exchange of the keyboard a cold boot must be performed
11. The current drivers are installed on the unit and initialized automatically by the cold boot.

ATTENTION

Incorrect handling may cause damage to property!

- ▶ Do not apply more than 0.5 NM or 4 in-lbs of torque when tightening the keypad screws.

7.3.3 Leather holster

BARTEC offers holsters to protect the MC 92N0^{ex}-IS.

⚠ DANGER

Non-certified accessories endanger explosion protection. There is a risk of fatal injury in an explosive atmosphere!

- ▶ Use only the original leather holsters.

Leather holster

- for MC 92N0^{ex}-IS with belt clip/turned part 03-9809-0026
- Turned part for holster 03-9809-0027
- Shoulder strap 03-9829-0091

7.4 Scanning

1. Ensure that an application is open on the device and a text field is in focus (text cursor in text field).
2. Point the top of the device at a barcode.
3. Press and hold the Scan button or trigger.
The red laser aiming pattern turns on to assist in aiming.
4. Ensure the barcode is within the area formed by the cross-hairs in the aiming pattern.
The aiming dot is used for increased visibility in bright lighting conditions.
The Scan LEDs light green and a beep sounds, by default, to indicate the barcode was decoded successfully.



8 Service, Inspection, Repair

Commissioning and service of Mobile Computers may be conducted exclusively by trained and qualified staff! The staff is familiar with the installation, assembly, commissioning and operation of the Mobile Computers, has been informed about the risks and has the qualifications necessary for this work.

8.1 Service intervals

The mechanical state of the device should be regularly checked. The service intervals will depend on the ambient conditions. We recommend that a service be conducted at least once a year. Regular servicing is not necessary if the device is correctly operated in accordance with the installation instructions and under appropriate consideration of the ambient conditions.



DANGER

Prevent electrostatic charging in potentially explosive atmospheres.

There is a risk of fatal injury in an explosive atmosphere!

- ▶ Do not dry wipe or clean devices.

8.2 Inspection

According to EN 60079-17, IEC 60079-17, EN 60079-19 and IEC 60079-19, the owner/operator of electrical plants in potentially explosive atmospheres is obliged to have these plants checked by an electrician to ensure that they are in a correct condition.

8.3 Service and repair work

In addition to Directive 99/92/EC, standards EN 60079-17, IEC 60079-17, EN 60079-19 and IEC 60079-19 also apply to the servicing and repair as well as the testing of accompanying operating devices.

Work connected with assembly/dismantling, operation and servicing may only be conducted by trained specialists. All statutory requirements and other binding guidelines on occupational health and safety, accident prevention and environmental protection must be observed.

8.3.1 Information on sending in for repairs

The following information is required for the repair.

- Series number of the device (see Type label)
- Model number or product name (see Type label)
- Software type and version number



Please read through the handling guidelines for the RMA process before you send in a defective device for repair. Then complete the RMA form (Return Merchandise Authorization), sign it and send it to our “Returns Centre”.

E-Mail: services@bartec.com

Fax: +49 7931 597-119

We cannot guarantee the processing within the contractually agreed period for any returns received by us without RMA number.

The handling guidelines and the RMA form are available for download from our website:

www.bartec.com

> Service

> Automation & Enterprise Mobility

If you have any questions, please send us an e-mail or give us a call.

E-Mail: services@bartec.com

Telephone: +49 7931 597-444

9 Disposal



Mobile Computer and accessories contains metallic and plastic parts and electronic components.





WEEE registration number of the BARTEC GmbH:
DE 95940350



As professional electrical devices, our devices are intended exclusively for commercial use, so-called B2B devices, in accordance with the WEEE Directive. The WEEE Directive provides the framework for the treatment of old electrical equipment throughout Europe. This means that you may not dispose of these devices in usual household waste but must dispose of them separately in an environmentally compatible manner and can also bring them to the collection points of public disposal companies. All products purchased from us can be returned to us by our customers for disposal. We will ensure disposal in accordance with the applicable laws. The sender shall bear the costs of postage and packaging.

10 Declaration of Conformity

10.1 EU Declaration of Conformity

EU Konformitätserklärung EU Declaration of Conformity Déclaration UE de conformité N° 11-A1A0-7C0001		
Wir	We	Nous
BARTEC GmbH Max-Eyth-Straße 16 97980 Bad Mergentheim Germany		
erklären in alleiniger Verantwortung, dass das Produkt MC92N0^{ex-IS}	declare under our sole responsibility that the product MC92N0^{ex-IS}	attestons sous notre seule responsabilité que le produit MC92N0^{ex-IS}
Typ 17-A1A* - ****/*****		
auf das sich diese Erklärung bezieht den Anforderungen der fol- genden Richtlinien (RL) entspricht ATEX-Richtlinie 2014/34/EU RED-Richtlinie 2014/53/EU RoHS-Richtlinie 2011/65/EU WEEE-Richtlinie 2012/19/EU und mit folgenden Normen oder nor- mativen Dokumenten übereinstimmt	to which this declaration relates is in accordance with the provision of the following directives (D) ATEX-Directive 2014/34/EU RED-Directive 2014/53/EU RoHS-Directive 2011/65/EU WEEE-Directive 2012/19/EU and is in conformity with the following standards or other normative documents	se référant à cette attestation correspond aux dispositions des direc- tives (D) suivantes Directive ATEX 2014/34/UE Directive RED 2014/53/UE Directive RoHS 2011/65/UE Directive WEEE 2012/19/UE et est conforme aux normes ou docu- ments normatifs ci-dessous
EN IEC 60079-0:2018 EN 60079-5:2015 EN 60079-11:2012 EN 60079-28:2015 EN 300 328 V2.2.2 EN 301 893 V2.1.1 EN 50581:2012 EN IEC 63000:2018	EN 301 489-1 V2.2.3 EN 301 489-17 V3.2.4 EN 55024:2010 EN 55032:2015/A11:2020 (Class B) EN 61000-3-2:2014 (Class A) EN 61000-3-3:2013	EN 62368-1:2014/AC:2015 EN 62368-1:2014/A11:2017 EN 62479:2010 EN 62311:2008 EN 62311:2020 EN 60825-1:2014 (Laser) EN 62471:2008 (LED) EN 50566:2017 (Max average 10g SAR:Limb 0.189 W/Kg)
Verfahren der internen Fertigungskontrolle	Procedure of internal control of production	Procédure de contrôle interne de fabrication
PTB 13 ATEX 2019 X 0102, PTB, Bundesallee 100, 38116 Braunschweig, DE		
 Bad Mergentheim, 04.11.2021		
 Osman Amith Authorized representative of BARTEC GmbH, At Bartec Pixavi AS Vestre Svanholmen 24 4313 Sandnes, Norway	 i.V. Michael Krüger VP Quality & Certification	
FB-0170d	Seite / page / page 1 von / of / de 1	

11 Note

BARTEC

BARTEC GmbH
Max-Eyth-Str. 16
97980 Bad Mergentheim
Germany

Phone: +49 7931 597 0
info@bartec.com

bartec.com